

To ensure correct operation and service please read these instructions before installing and operating the TPMS

# TPMS Manual

## TABLE OF CONTENTS

|  |           |
|--|-----------|
| <b>TIRE PRESSURE MONITORING SYSTEMS, TPMS.....</b>   | <b>2</b>  |
| <b>NOTICE .....</b>  | <b>2</b>  |
| <b>SPECIFICATIONS OF TPMS .....</b>  | <b>3</b>  |
| <b>SYSTEM INSTALLATION .....</b>   | <b>3</b>  |
| <b>ACCESSORIES FOR TIRE PRESSURE MONITORING SYSTEM .....</b>                               | <b>4</b>  |
| <b>DISPLAY UNIT INSTALLATION .....</b>   | <b>4</b>  |
| <b>WIRELESS TRANSMITTER SENSOR INSTALLATION .....</b>                                      | <b>5</b>  |
| <b>SYSTEM OPERATION .....</b>  | <b>9</b>  |
| <b>SYSTEM ALARM.....</b>   | <b>9</b>  |
| <b>SETUP METHOD.....</b>   | <b>9</b>  |
| <b>Choosing preferred Pressure Units and Temperature Units .....</b>                       | <b>10</b> |
| <b>Standard Front/Rear Tire Pressure Setting .....</b>                                     | <b>11</b> |
| <b>Tire Over Temperature Warning .....</b>   | <b>11</b> |
| <b>Alarm Instruction.....</b>  | <b>12</b> |
| <b>RESET FOR TIRE CHANGES AND ROTATION.....</b>  | <b>13</b> |
| <b>Mode 1: Front to Rear tires exchanged.....</b>  | <b>14</b> |
| <b>Mode 2 : Tires diagonal exchanged.....</b>  | <b>15</b> |
| <b>Mode 3 : Front tires diagonal exchanged, and Rear tires parallel changed to Front..</b> | <b>16</b> |
| <b>Mode 4 : Random re-position tires.....</b>  | <b>17</b> |
| <b>Mode 5 : Single sensor replaced.....</b>  | <b>18</b> |
| <b>APPENDIX.....</b>   | <b>19</b> |
| <b>ANNEXES.....</b>  | <b>19</b> |
| <b>WARRANTY POLICY .....</b>   | <b>20</b> |
| <b>TROUBLESHOOTING GUIDE.....</b>  | <b>21</b> |



To ensure correct operation and service please read these instructions before installing and operating the TPMS

## **Tire Pressure Monitoring Systems, TPMS**

Tire Pressure Monitoring Systems (TPMS) improves safety while driving. Once installed in your vehicle, the system will automatically monitor your tires in real-time for pressure and temperature. When any tire's pressure and/or temperature appear abnormal, the system will, in real-time, transmit signals to activate an alarm and show a digital figure to warn the driver of a problem. The system aids safety, can extend the tire life and help reduce fuel consumption.

### **NOTICE**

#### **FCC Notice**

This device complies with Part 15 of the FCC Rules. Operation is subject to the following two conditions: (1) this device may not cause harmful interference, and (2) this device must accept any interference received, including interference that may cause undesired operation.

This equipment has been tested and found to comply with the limits for a Class B digital device, pursuant to Part 15 of the FCC Rules. These limits are designed to provide reasonable protection against harmful interference in a residential installation. This equipment generates uses and can radiate radio frequency energy and, if not installed and used in accordance with the instructions, may cause harmful interference to radio communications. However, there is no guarantee that interference will not occur in a particular installation.

If this equipment does cause harmful interference to radio or television reception, which can be determined by turning the equipment off and on, the user is encouraged to try to correct the interference by one or more of the factoring measures.

- Reorient or relocate the receiving antenna.
- Increase the separation between the equipment and receiver.
- Connect the equipment into an outlet on a circuit different from that to which the receiver is connected

**Caution:** Any changes or modifications in construction of this device which are not expressly approved by the party responsible for compliance could void the user's authority to operate the equipment.

To comply with the FCC RF exposure compliance requirements, this device and its antenna must not be co-located or operating to conjunction with any other antenna or transmitter.

#### **System Scope of Use and Warnings**

##### Tire Pressure Monitoring System, TPMS

This system is a sensing device designed to measure and display tire operation and / or activate an alert to the driver when pressure and temperature irregularities are detected. It is the responsibility of the driver to react promptly and with discretion to alerts. Abnormal tire inflation pressure should be corrected at the earliest opportunity.

**Caution:** The system is wireless RF product; therefore, it may not receive signal due to interference environment or incorrect operating or installation. When the system continually cannot receive signal from one of the tire sensor more than 20 minutes since the system be switched on, the system will show " E2 ". In this case, it may cause by a RF interference environment and driver needs to drive the vehicle to other place. If the display still cannot receive any correct signal from tire sensor, then, driver needs to find a nearby qualified tire maintain service for checking and maintain. It may cause by a tire sensor damaged or battery power consumption is low (the battery consumption will be lower than under normal using condition due to sensors need to send warning signal continually to driver) . If the system continually cannot receive signal from any sensors more than 20 minutes, the system might damaged and will show "E1". Driver needs to drive to other place (there might be a interference nearby) or send the system to agent for repair

#### **\* System Installation and Usage**

Use of the TPMS requires that qualified personnel according to the instructions here have properly installed it. This system is suitable for use on a passenger car, SUV and 4X4 tires, with up to maximum cold inflation pressure of 74 Psi (Gauge), below instruction is Gauge value mentioned.

**\* Reacting to Alerts**

When an alert or warning is received, reduce vehicle's speed and proceed to a safe location to stop where the tire can be inspected and /or serviced.

The low-pressure alert indicates that the air pressure has dropped to a selected minimum and a high-temperature alert indicates that the temperature of the tire content has surpassed the threshold value set. When the battery voltage icon flash, it means the battery voltage of vehicle is below battery voltage default (11v).

**\* Use of Chemicals**

Temporary resealing or re-inflation products containing internal sealants or propellants in any tire assembly may adversely affect the operation of the sensor/transmitter.

**Specifications of TPMS**

| RECEIVER SPECIFICATIONS               |  |
|---------------------------------------|--|
| Operating voltage                     | 12V DC   |
| Operating current                     | < 200mA  |
| Storage temperature                   | -30°C to 75°C  |
| Operating temperature                 | -25°C to 75°C  |
| SENSOR AND TRANSMITTER SPECIFICATIONS |  |
| Storage temperature                   | -40°C to 125°C   |
| Operating temperature                 | -40°C to 125°C   |
| Operating humidity                    | Max 95%  |
| Operating frequency                   | 433.92MHz ± 50kHz                                      |
| Pressure monitoring range             | 0~74 psi   |
| Pressure reading accuracy             | At Normal condition<br>± 1psi at normal pressure range |
| Temperature reading accuracy          | ± 4°C in normal environmental condition                |
| Transmission power                    | Max 75 dBµV/m  |
| Battery                               | 3V   |
| Sensor weight                         | 28g ±3g  |

**System Installation**

There are two parts of system installation

1. Setting up the display unit in the vehicle
2. Installing the transmitter unit sensor in each tire.

We strongly suggest installing the display unit first, and then install the tire transmitters.

**Note:** Warranty including "Wireless Display Unit and Wireless Transmitter Sensor and Power Connection cable", not including other accessories.

When remove transmitter sensors to different tires and replace new transmitter sensors, suggest to change all of the valve stems and screws.

## Accessories for Tire Pressure Monitoring System

| NO. | Accessory Name                              | Quantity |
|-----|---|----------|
| A   | Wireless Receiver and Display Unit          | 1        |
| B   | Velcro for Display                          | 1 set    |
| C   | Power Connection for Cigarette Lighter      | 1        |
| D   | Wireless Transmitter Sensor with Valve Stem | 4        |
| E   | Valve Nut                                   | 4        |
| F   | Nut for stand                               | 1        |
| G   | Base (for display unit)                     | 1        |
| H   | Windshield holder                           | 1        |
| I   | 3M Double-Coated Adhesive                   | 1        |

**Caution:** the power connection is NOT COMPATIBLE with USB interface; please do not plug in any USB devices.

## Display Unit Installation

1. Plug in one side of C the power cable connection into A the display located on the side.
2. Connect the power cable into the vehicle's cigarette lighter socket for power connection.  
(or cut the cigar jet. plug the power cable with ACC, Positive, Negative into fuse box)

**Note:** Plugging the power cable with ACC, Positive, Negative into fuse box, the LED light will turn on only when ACC is on and the LED light will be off when ACC is turned off.

3. Install the display unit in front of driver at an appropriate position.  
Stick the Velcro B into the bottom of the display unit A, and Stick the unit into the convenient place.
4. After set up the monitor please take off the protection film from the panel of monitor.

Installing steps:

Step1: Take off white film of Velcro (B) and adhere to Base (G). Adhere the other Velcro (B) to the back of the Wireless Receiver and Display Unit.

Step2: Screw Nut for stand (F) to the Base (G).

Step3: Attach the head of base (G) to the windshield holder, and screw the nut tightly.

Step4: Use any side of 3M double-coated Adhesive (I) to windshield holder, another side is adhered to windshield.

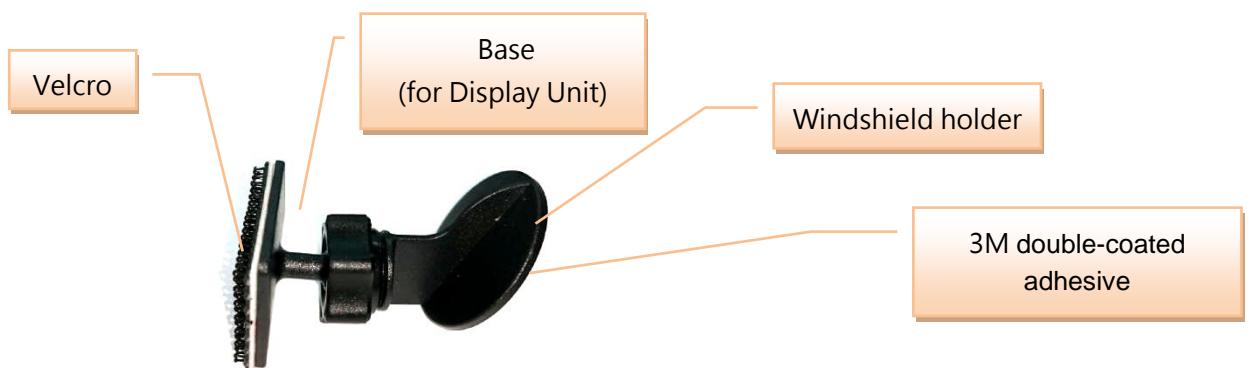

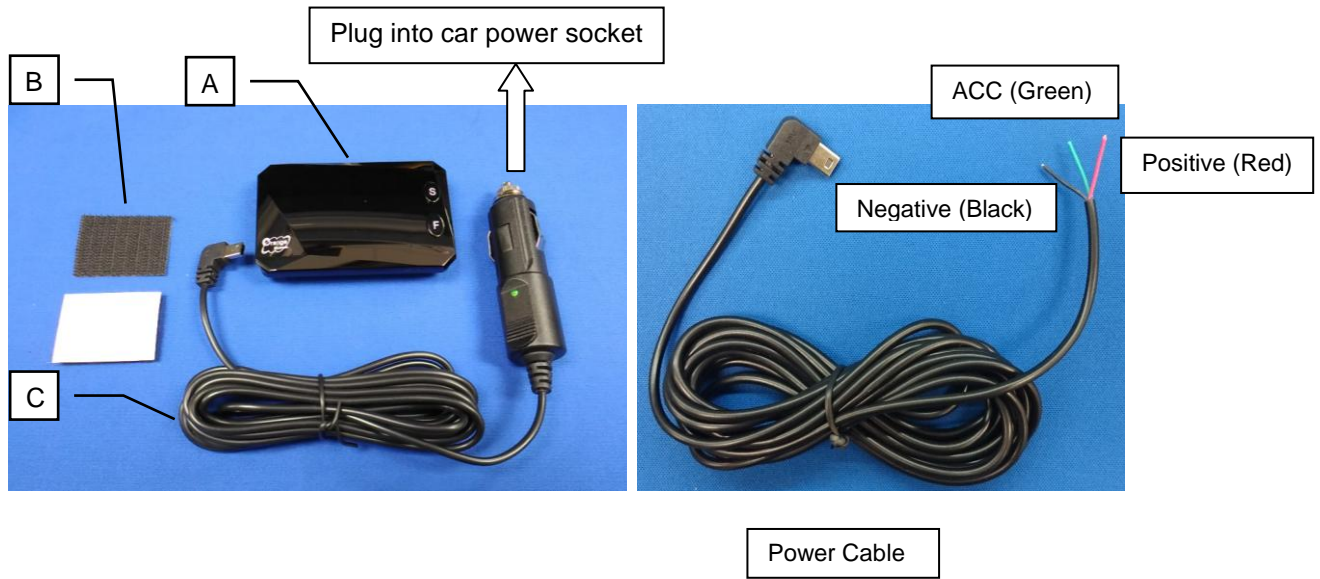



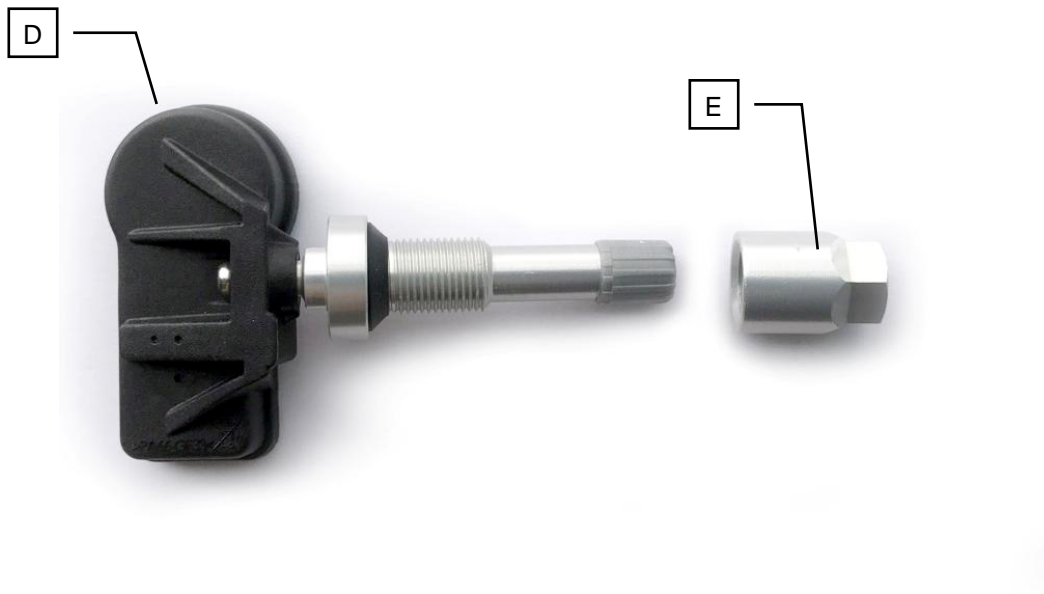

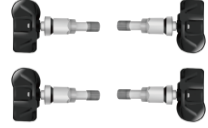

**Wireless Transmitter Sensor Installation**

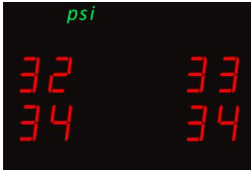

| Step | Operation Process  | Photograph  |
|------|--|---|
| 1    | Use a jack to raise the vehicle and place jack stands underneath the vehicle for safety. Refer to vehicle owner's manual for full service advice. Seek the assistance of a qualified motor mechanic if required. |  |

|   |   |   |
|---|---|---|
| 2 | <p>Take off the tires and bleed the air. Then take off the air valve of the tire from the wheel. <b>(NOTE: You must change the valve to TPMS valve)</b>. This part of the process will normally require the service of a tire fitting service or mechanic.</p>  |    |
| 3 | <p>Recognize the number on each sensor (D) with position of tire on the vehicle. (VERY IMPORTANT)</p> <p>a. <b>RF - 1 = Right Front, No. 1</b><br/> b. <b>RR - 2 = Right Rear, No. 2</b><br/> c. <b>LR - 3 = Left Rear, No. 3</b><br/> d. <b>LF - 4 = Left Front, No. 4</b></p>   |    |
| 4 | <p>Set up the new TPMS special valve (E) in the wheel. Use wrench to fix the valve, and then tighten nut to 40~45kgf-cm (4~4.5Nm).</p>  |    |
| 5 | <p>Clean inside the tire to prevent the tire from damaging the transmitter sensor.</p>  |   |
| 6 | <p><b>Inflate the tires.</b></p> <p>Balance the tire</p> <p>a. Balance tires using a balance machine<br/> b. A lead tire weight may need to be added for balancing.<br/> c. Balance until the tire balance shows balance as "OK"</p> <p>The Steps above will require the assistance of a tire fitting service or a mechanic. It is important that the wheels are balanced after the fitting of the TPMS sensors in order to ensure the safe operation of the tire when refitted to the vehicle. °</p> |    |
| 7 | <p>Set up the other three tires in the same manner.</p>   |    |
| 8 | <p>Turn the ignition key of the vehicle until the power is activated on the cigar lighter, this may be first or second position depending on the car manufacturer. The in-car display will be activated.<br/> The function button of the display unit can be switched to pressure or temperature depending on the customer's need.</p>  |    |

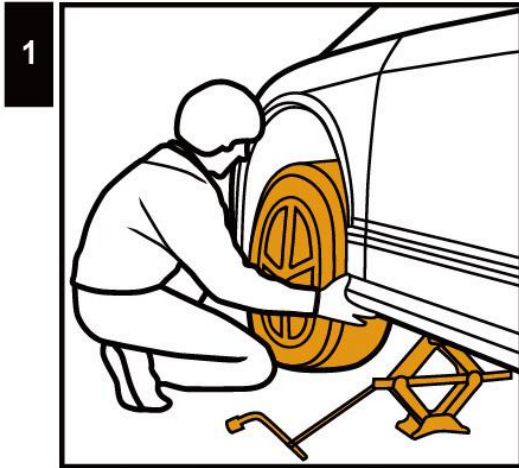

1 Jack up the car and de-mount the tire.

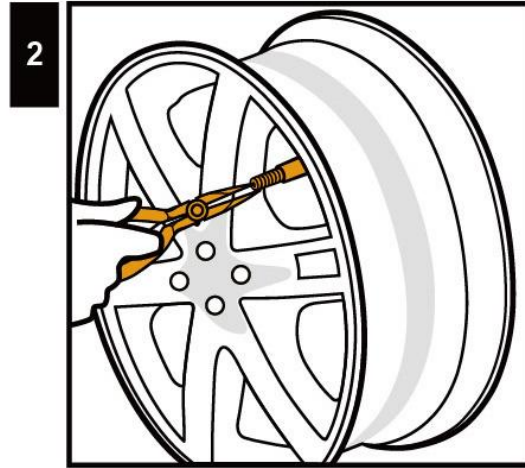

2 Remove original valve.

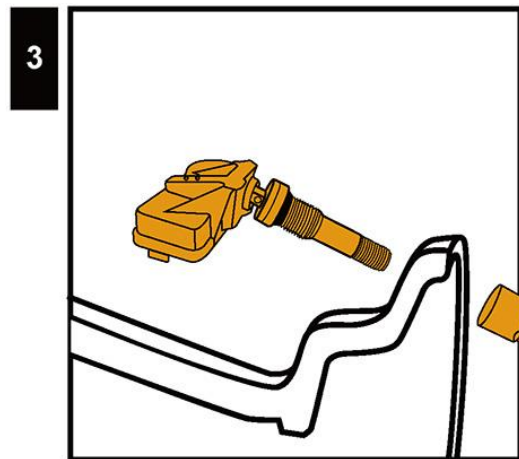

3 Sensor Assemble

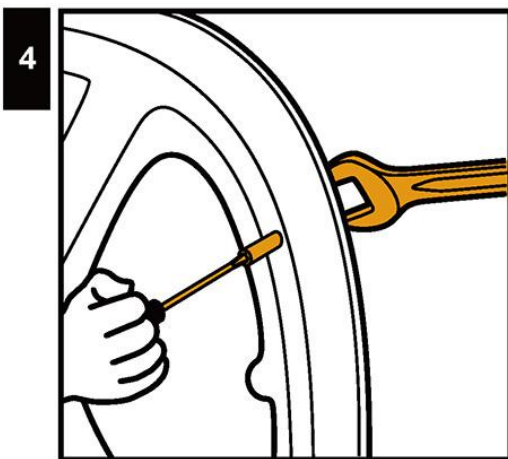

4 Tighten the valve by wrench and screw it ( Torque value must be  $\geq 4.5\text{Nm} \sim 5\text{Nm}$ )

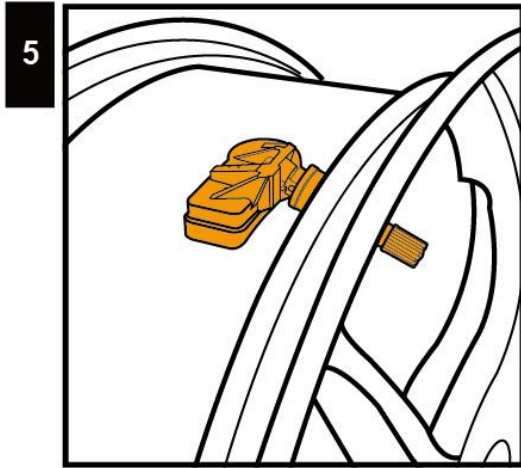

Tighten up screw

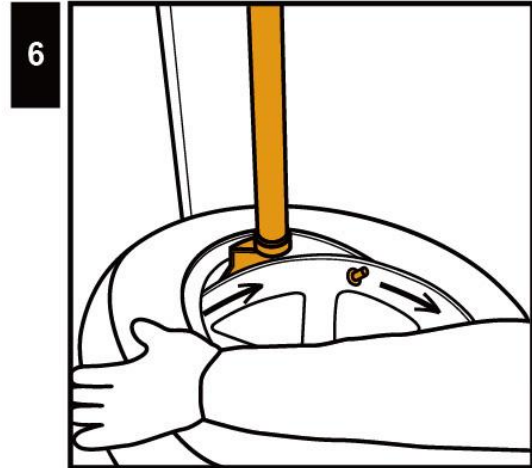

Install the tire from left side of the valve clockwise direction, avoid tire bead hits valve and sensor.

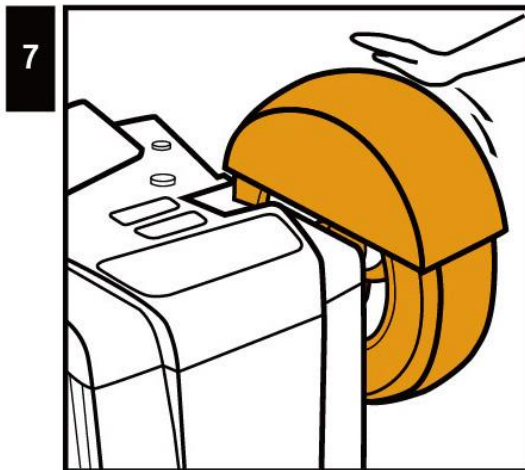

Balance the tire.

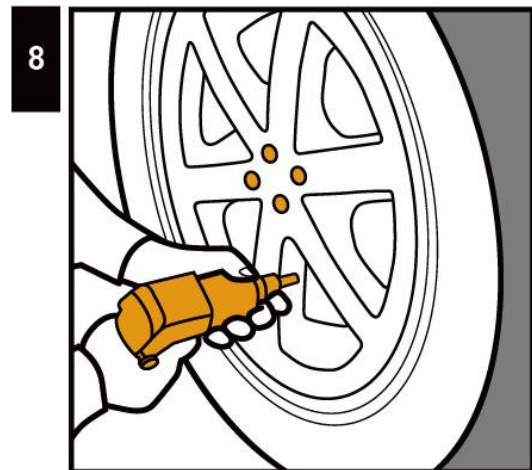

Mount the tire to it's position.



## System Operation

After the system is installed, it will automatically monitor the tire pressure and temperature. Once the ignition is turned on, and the vehicle is in motion, the display will show the real-time tire pressure and temperature individually.

## System Alarm

The alarm system will start, if tire pressure is too low, and if tire temperature is too high, the alarm system will start too, and tire pressure will show on display. If high tire temperature and low tire pressure situation happen at the same time, the system will show low tire pressure at first and then show tire temperature, both of tire pressure and temperature will show on the screen for six seconds by turns.

The alarm will keep making sound till turning off alarm system or solving abnormal situation, and below the manual will explain operation process.

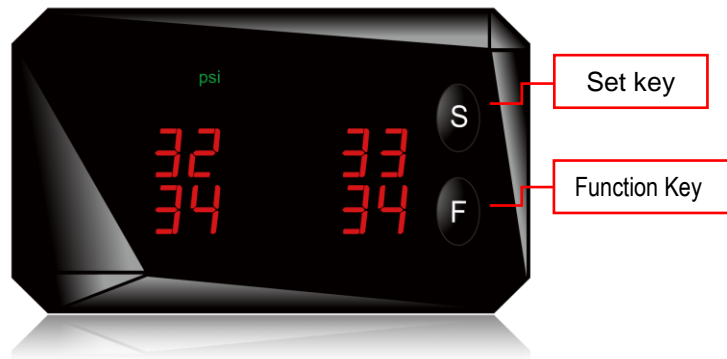

## Setup Method





The driver can follow the steps to adjust the system of pre-loaded values

※Notice: The system has been pre-set with alert figures. If the driver wants to change the figure, then follow the professional tire technician's instruction.

Choosing preferred Pressure Units and Temperature Units

| Step | Operation process   | Photograph  |
|------|---|---|
| 1    | <p>By pressing the <b>function key</b>, it will switch among displaying the pressure unit, displaying the temperature unit, displaying the battery voltage, and displaying both pressure unit and temperature unit by turns. The operator can choose which one to set up first.</p> |    |
| 2    | <p>If the pressure unit is chosen. Press the <b>function key</b> for 3 seconds, it will switch to kPa, psi, bar in turn. Once the preferred unit is chosen release the <b>function key</b>.</p>   |   |
| 3    | <p>If the temperature unit is chosen. Press the <b>function key</b> for 3 seconds, it will switch to °C and °F in turn. Once the preferred unit is chosen release the <b>function key</b>.</p>  |  |

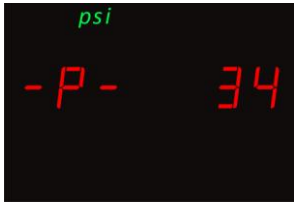
**Standard Front/Rear Tire Pressure Setting**

| Step | Operation process  | Photograph  |
|------|--|---|
| 1    | Pressing the <b>set key</b> for over 3 seconds can change to the front tire standard pressure set up mode.   | <b>【Set】 Key</b>  |
| 2    | The wireless receiver and display unit will show the preset front tire standard pressure default (34 psi / 230 kPa / 2.3 bar).   |    |
| 3    | By pressing the <b>function key</b> once, the psi value will add 1 unit; and the unit value will return to 20 psi when it has reached 48 psi. ( the kPa value will add 10 units; and the unit value will return to 140 kPa when it has reached 330kPa / the bar value will add 0.1 units; and the unit value will return to 1.4bar when it has reached 3.3 bar) The system will use this setting as the standard value for low tire pressure monitoring, which means when the tire has deflated to a pressure value lower than this setting, the system will automatically start to warn the driver. | <b>【Function】 Key</b>   |
| 4    | As for the preset standard value 34psi/230kpa for tire pressure monitoring. High tire pressure monitoring which means when tire pressure has reached 51psi or 1.5 times of the original standard value (the initial preset value is 345kPa or 3.5 bar).<br>For low tire pressure monitoring which means when tire pressure has reached 27psi or 0.8 times of the original standard value (the initial present value is 184 kPa or 1.8bar).   |   |
| 5    | Press the <b>set key</b> to complete the front tire pressure warning value setup mode. The system will automatically enter the rear tire pressure set up mode.   | <b>【Set】 Key</b>  |
| 6    | Set up rear tire standard pressure value by using the same steps 1~5 from front tire pressure warning value set up mode.   |  |

**Tire Over Temperature Warning**

| Step | Operation process   | Photograph  |
|------|---|---|
| 1    | After the setting operation of standard tire pressure, the systems will automatically entry the setting mode of high tire temperature.    |   |
| 2    | The display unit will show tire over temperature warning setup value ( <b>the factory default value is 80°C / 176°F.</b> ) for the tires. |  |

|   |  |                       |
|---|--|-----------------------|
| 3 | <p>Press the <b>function key</b> to change the high temperature figure.</p> <p>The high temperature figure set up range is from 60°C to 100°C ( the °F value will add 1 unit; and the unit value will return to 140 °F when it has reached 212 °F), the driver can continually push the <b>function key</b> to adjust the appropriate high temperature figure. When the tire temperature exceeds this setting, the system will generate the warning signals.</p> | <b>【Function】 Key</b> |
| 4 | <p>Press the <b>set key</b> to complete the high temperature setting operation.</p>  | <b>【Set】 Key</b>      |

**Alarm Instruction**

| Type | Warning Description  | Photograph |
|------|--|------------|
| 1    | <p>The tire pressure of RF Tire (22 psi) is below tire pressure default (27 psi), and it will active an alarm with “Beep sound” to warn the driver, press <b>set key</b> to turn off the alarm.</p>                      |            |
| 2    | <p>The tire pressure of LF Tire (52 psi) is above tire pressure default (51 psi), and it will active an alarm with “Beep sound” to warn the driver, press <b>set key</b> to turn off the alarm.</p>                      |            |
| 3    | <p>The tire temperature of LR Tire (82 °C) is above tire temperature default (80 °C), and it will active an alarm with “Beep sound” to warn the driver, press <b>set key</b> to turn off the alarm.</p>                  |            |
| 4    | <p>The battery voltage of Sensor is under battery voltage default, which the battery check icon will illuminate.</p>   |            |
| 5    | <p>When display is not in battery monitor mode, the battery voltage icon will flash to warn the driver, when the battery voltage of vehicle is below 11V.</p>  |            |
| 6    | <p>When it lasts 20 minutes above that wireless receiver couldn't receive one of the signal from wireless transmitter sensor, the display will show E2; E1 indicates all wireless transmitter sensor not receivable.</p> |            |

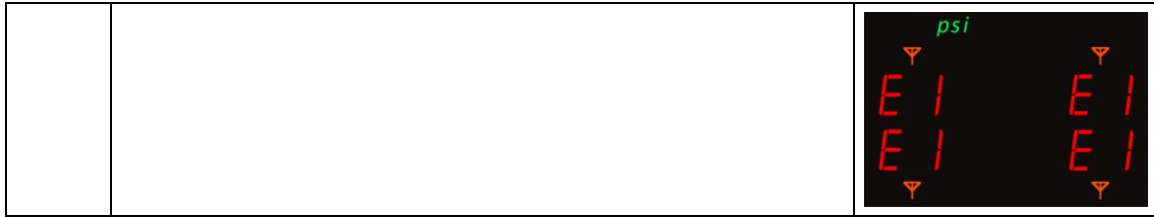

**Note** when display unite shows E1 or E2, place any wireless devices (cell phone, etc) further away from display unit or locate a qualified tire service center to correct the issue.

### Reset for Tire Changes and Rotation

The rotation is necessary to prolong the life of your tires. The system can reset the tire position to ensure the transmitter sensor can indicate the right position of your tires on display unit. TPMS provides three modes of tire rotation methods and one mode for random repositioning and single sensor replacement.

The product has adopted Orange Tire Orientation (OTO).

The system will automatically reset tire position on driving for a while after tire or sensor change.

OTO can efficiently help end user save time for resetting.

Mode 1: Front to Rear tires exchanged

Mode 2: Tires diagonal exchanged

Mode 3: Front tires diagonal exchanged, and Rear tires parallel exchanged to Front.

Mode 4: Random tire repositioning

Mode 5: Single sensor replaced

- No.1 → Front-right tire
- No.2 → Rear-right tire
- No.3 → Rear-left tire
- No.4 → Front-left tire







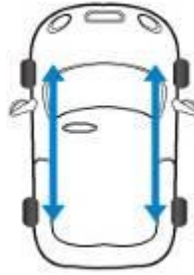

### Warming

1. Do not turn off the vehicles power during this process. Doing so will immediately interrupt the repositioning setup process. The ignition can either be in the on or start position (At this time, enter Mode 5 to use single sensor replaced).
2. After repositioning, check the display is detecting all tire pressures correctly. If the system cannot work normally, please reset it and follow the instructions again.





**Mode 1: Front to Rear tires exchanged**



| Step | Operation process   | Photograph   |
|------|---|--|
| 1    | Rotate the tires. Front to Rear, and Rear to Front. To prevent incorrect positioning, mark the tires.   |   |
| 2    | Press both the <b>set key</b> and <b>function key</b> simultaneously for 5 seconds. The display will flash red, and a “beep” sound will be heard. You can release the buttons, and the system will have entered into mode 1.  | <p><b>【Function】 Key</b><br/><b>【Set】 Key</b></p>  |
| 3    | <p>3-1<br/>After entering mode 1, the display will show “1”.</p> <p>3-2<br/>Numbers show in LED lights stands for tires’ ID, photograph ① and ③ means tires position before changing, photograph ② and ④ means after changing.</p> <p>3-3<br/>The operator only needs to press the <b>set key</b> for 3 second and listen for the “beep”. This means that mode 1 has been chosen and will exchange all four sensors ID positions and will automatically return the monitoring status to normal.</p> |      |





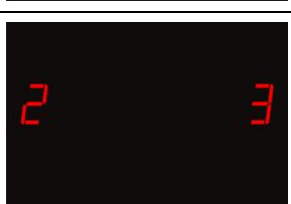

**Mode 2 : Tires diagonal exchanged**



| Step | Operation process  | Photograph   |
|------|--|--|
| 1    | Rotate the tires diagonally. To prevent from incorrect positioning, mark the tires.  |   |
| 2    | Press both the <b>set key</b> and <b>function key</b> simultaneously for 5 seconds. The display will flash red, and a “beep” sound will be heard. You can release the buttons, and the system has entered into mode 1. If presses <b>function key</b> again, then the system has entered into mode 2.  | <p><b>【Function】 Key</b><br/><b>【Set】 Key</b></p>  |
| 3    | <p>3-1<br/>After entering mode 2, the display will show “2”.</p> <p>3-2<br/>Numbers show in LED lights stands for tires’ ID, photograph ① and ③ means tires position before changing, photograph ② and ④ means after changing.</p> <p>3-3<br/>The operator only needs to press the <b>set key</b> for 3 second and listen for the “beep”. This means the mode 2 has been chosen and will exchange all four sensors ID positions and will automatically return the monitoring status to normal.</p> |      |



**Mode 3 : Front tires diagonal exchanged, and Rear tires parallel changed to Front**







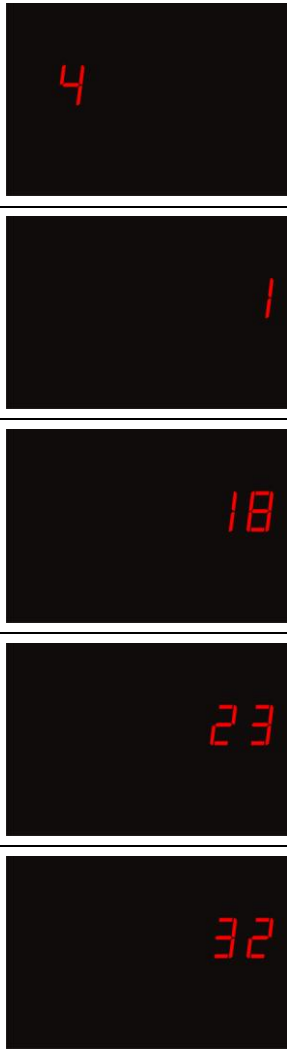

| Step | Operation process  | Photograph  |
|------|--|---|
| 1    | Rotate the front tires diagonally to the rear, and the rear tires parallel to the front. To prevent incorrect positioning, mark the tires.   |    |
| 2    | Press both the <b>set key</b> and <b>function key</b> simultaneously for 5 seconds. The display will flash red light, and a “beep” sound will be heard. You can release the buttons, and the system will have entered into mode 1. Re-press <b>function key</b> for 1 second and wait for “beep” then the LED will show “2”, re-press the <b>function key</b> you will then see “3”, the system will have entered into mode 3.   | <p data-bbox="1114 831 1362 904"><b>【Function】 Key</b><br/><b>【Set】 Key</b></p>   |
| 3    | <p data-bbox="357 1317 916 1375">3-1<br/>After entering mode 3, the display will show “3”</p> <p data-bbox="357 1413 1070 1559">3-2<br/>Numbers show in LED lights stands for tires’ ID, photograph ① and ③ means tires position before changing, photograph ② and ④ means after changing.</p> <p data-bbox="357 1603 1070 1749">3-3<br/>The operator only needs to press the <b>set key</b> for 3 second and listen for the “beep”. This means that mode 3 has been chosen and will exchange all four sensors ID positions and will automatically return the monitoring status to normal.</p> |      |

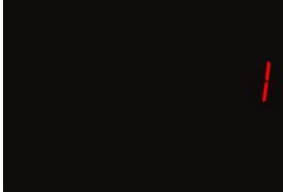

**Mode 4 : Random re-position tires**

| Step | Operation process  | Photograph  |
|------|--|---|
| 1    | The tire shop will check the tire for abrasion and rotate tires into the appropriate position.   |    |
| 2    | Press both the <b>set key</b> and <b>function key</b> simultaneously for 5 seconds. The display will flash red, and a “beep” sound will be heard. You can release the buttons the system will have entered into mode 1. Continue to press the function key, each time for one second and each time wait for the beep until the display shows “4”. After entering into mode 4 the LED will show “4”.  | <p><b>【Function】 Key</b><br/><b>【Set】 Key</b></p>                                     |
| 3    | <p>3-1<br/>It will take about two second after entering mode 4, and the display will show “4”.</p> <p>3-2<br/>When Tire No.1 needs to be reconfigured, deflate Tire No.1 once below 27 psi (tire low pressure default), and wait for the receiver to receive the signal. When tire No. 1 receives the signal, you will hear alarm “beep”. Then, start inflate the tire No.1, it will keep on “beep” till Tire No. 1 is completely inflated to normal pressure.</p> <p>3-3<br/>After finishing all the steps above. In the mode 4, the numbers will show “1” and turn to “2” automatically.</p> |   |
| 4    | Repeat the 3-2 step above for tire No.2, No.3 and No.4 System will be back to monitoring condition automatically, and receiver start to receive signals of tire pressure & tire temperature.   |  |

**Mode 5 : Single sensor replaced**

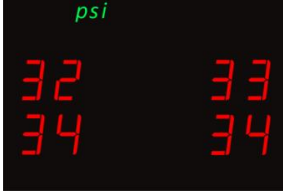
| Step | Operation process  | Photograph   |
|------|--|--|
| 1    | Take off the broken sensor and replace it with a new sensor. ( if you are only checking for a signal problem from Mode 4 instructions, there is no need to take off the sensor)  |   |
| 2    | Press both the <b>set key</b> and <b>function key</b> simultaneously for 5 seconds. The display will flash red, and a “beep” sound will be heard. You can release the buttons, and the system will have entered into mode 1. Continue to repress the function key for four times, and then the system will switch into mode 5. °   | <p><b>【Function】 Key</b><br/><b>【Set】 Key</b></p>  |
| 3    | <p>3-1<br/>It will take about 2 seconds after entering mode 5, the display will show “5”</p> <p>3-2<br/>Press <b>set key</b> to choose tire which new sensor installed, LED will show Tire No.1 / 2 / 3 / 4.</p> <p>3-3<br/>When Tire No.1 (RF Tire) needs to be replaced, deflate tire No.1 below 27 psi (tire low pressure default value) and wait for the receiver to receive the signal. When Tire No. 1 receives the signal, you will hear “beep”. Then, start inflate tire No.1, it will keep on “beep” till Tire No. 1 is completely inflated to normal pressure.</p> |      |
| 4    | After completing all the steps above, System will be back to monitoring condition automatically.   | <p>psi</p>    |

**Appendix**

**Glossary**

|                                |  |
|--------------------------------|--|
| kPa                            | Pressure reading in Kilo Pascal  |
| psi                            | Pressure reading in pound per square inch  |
| bar                            | Pressure reading in bar  |
| °C                             | Temperature reading in degrees Celsius   |
| °F                             | Temperature reading in degrees Fahrenheit  |
| Inflating Pressure environment | Recommended inflation pressure of a tire at ambient temperature of 25°C / 77 °F by vehicle manufacturers.  |
| Low Pressure Alert             | Visual and audible warning, this is activated when the tire's pressure goes below the preset level. Initial low pressure alert is 27 psi             |
| High Pressure Alert            | Visual and audible warning, this is activated when the tire's pressure goes higher than the preset level. Initial High pressure alert is 51 psi      |
| High Temperature Alert         | Visual and audible warning, this is activated when the tire's temperature goes higher than the preset level. Initial High temperature alert is 80°C. |
| Display / Receiver Module      | The electronic module mounted inside the vehicle that alerts the driver of any tire irregularities.  |
| Sensor / Transmitter Module    | The electronic module mounted on the wheels that measure the air pressure and temperature of the tire.   |

**Annexes**

**Annex 1**

**kPa , psi, bar Conversion Table**

| kPa | psi | bar | kPa | psi | bar | kPa | psi | bar |
|-----|-----|-----|-----|-----|-----|-----|-----|-----|
| 10  | 1   | 0.1 | 210 | 30  | 2.1 | 410 | 59  | 4.1 |
| 20  | 3   | 0.2 | 220 | 32  | 2.2 | 420 | 61  | 4.2 |
| 30  | 4   | 0.3 | 230 | 33  | 2.3 | 430 | 62  | 4.3 |
| 40  | 6   | 0.4 | 240 | 35  | 2.4 | 440 | 64  | 4.4 |
| 50  | 7   | 0.5 | 250 | 36  | 2.5 | 450 | 65  | 4.5 |
| 60  | 9   | 0.6 | 260 | 38  | 2.6 | 460 | 67  | 4.6 |
| 70  | 10  | 0.7 | 270 | 39  | 2.7 | 470 | 68  | 4.7 |
| 80  | 12  | 0.8 | 280 | 41  | 2.8 | 480 | 70  | 4.8 |
| 90  | 13  | 0.9 | 290 | 42  | 2.9 | 490 | 71  | 4.9 |
| 100 | 15  | 1   | 300 | 44  | 3.0 | 500 | 73  | 5   |
| 110 | 16  | 1.1 | 310 | 45  | 3.1 | 510 | 74  | 5.1 |
| 120 | 17  | 1.2 | 320 | 46  | 3.2 | 520 | 75  | 5.2 |
| 130 | 19  | 1.3 | 330 | 48  | 3.3 | 530 | 77  | 5.3 |
| 140 | 20  | 1.4 | 340 | 49  | 3.4 | 540 | 78  | 5.4 |
| 150 | 22  | 1.5 | 350 | 51  | 3.5 | 550 | 80  | 5.5 |
| 160 | 23  | 1.6 | 360 | 52  | 3.6 | 560 | 81  | 5.6 |
| 170 | 25  | 1.7 | 370 | 54  | 3.7 | 570 | 83  | 5.7 |
| 180 | 26  | 1.8 | 380 | 55  | 3.8 | 580 | 84  | 5.8 |
| 190 | 28  | 1.9 | 390 | 57  | 3.9 | 590 | 86  | 5.9 |
| 200 | 29  | 2   | 400 | 58  | 4.0 | 600 | 87  | 6   |

**Annex 2**

| <b>°C To °F and °F To °C Conversion Table</b> |           |           |           |           |           |
|---|-----------|-----------|-----------|-----------|-----------|
| <b>°C</b>                                     | <b>°F</b> | <b>°C</b> | <b>°F</b> | <b>°C</b> | <b>°F</b> |
| -40   | -40       | 20        | 68        | 80        | 176       |
| -30   | -22       | 30        | 86        | 90        | 194       |
| -20   | -4        | 40        | 104       | 100       | 212       |
| -10   | 14        | 50        | 122       | 110       | 230       |
| 0   | 32        | 60        | 140       | 120       | 248       |
| 10  | 50        | 70        | 158       | 125       | 257       |

**Warranty Policy**

We warrant our products for one year (365 days) from the date of original purchase to be free from defects in materials and workmanship. If, during this period, the product fails under normal usage, because of a manufacturing defect, we will replace or repair the item. To obtain repair or replacement under the terms of this warranty, please return the product to the place of purchase. Proof of purchase and date of purchase are required to validate the warranty claim.

All implied warranties, including the warranty of merchantability, are limited to this same ninety-day period from date of original purchase. We are not liable for any direct or consequential loss or property damage arising from any use of this product. This warranty gives you specific legal rights, and you may also have other rights, which vary from state to state.

This does not affect your statutory rights.

**Note: Warranty including “Wireless Display Unit and Wireless Transmitter Sensor and Power Connection cable”, not including other accessories.**

**When remove transmitter sensors to different tires and replace new transmitter sensors, suggest changing all the valve steams and screws.**

**Warning**

- 1. Only use TPMS sensor replacement parts (these can be purchased from Agents). TPMS cannot use other brands of TPMS sensors for replacement parts. Using other brands will be cause failure and will void the warranty.**
- 2. The power connection is NOT COMPATABLE with USB interface; please do not plug in any USB devices.**

Any questions pertaining to warranty information or other questions not answered in the preceding pages can be answered by the place of purchase or by Orange Electronic service e-mail address:

[service@orange-electronic.com](mailto:service@orange-electronic.com)

For updated TPMS information and Orange products visit the Orange Electronic website:  
[www.orange-electronic.com](http://www.orange-electronic.com)

---

Thank you for your purchase and enjoy your TPMS!

## Troubleshooting Guide

1. The receiver shows no sign or any information after its power is turned on.

|   |
|---|
| 1.The power cord connector is not fully contacted with the receiver   |
| Solution: Remove the power cord and plug it into the outlet again until it is contacted completely.   |
| 2.The power cord failed   |
| Solution : Ask your distributor to have your power cord replaced and send the defected one back to manufacturer for repair.   |
| 3. The battery is run out of power.   |
| Solution : If the battery voltage is always lower than 9V every time you start the engine, it is recommended that the car should be brought to the service center for inspection. |
| 4. The digits shown on the display panel become incomplete, or the light indicators become abnormal.  |
| Solution : Send the defected receiver display back to agent for repair and reconfigure its ID using the Tire Switching Mode (Mode IV).  |
| 5. The fuse is blown in display   |
| Solution : Send the defected receiver display back to agent for repair and reconfigure its ID using the Tire Switching Mode (Mode IV).  |

2. The Set button or the Conversion button has no response.

|   |
|---|
| 1. The inner circuits of the receiver failed  |
| Solution : Ask your distributor to have your receiver replaced, reconfigure its ID using the Tire Switching Mode (Mode IV), and send the defected receiver back to manufacturer for repair. |

3. The receiver cannot receive signal from one or some certain tires (but not all of them) after its power is turned on the numeric values representing the locations of those tires displayed on the screen become "E2".

|   |
|---|
| 1. There is interference from other electronic device in the vehicle.   |
| Solution : Remove other electronic device in the vehicle to determine if TPMS is interfered by those removed devices.   |
| 2. The IDs of those tires do not set up correctly   |
| Solution : Ask your installation supplier to reconfigure the IDs of those tires by using the Single Sensor Replacement Mode(Mode V)   |
| 3. The transmitter of those tires failed.   |
| Solution : Ask your distributor to have those transmitters replaced, reconfigure the IDs of those tires by using the Single Sensor Replacement Mode (Mode V), and then send the defected transmitter back to manufacturer for repair. |

4. The receiver cannot receive signal from any of the four tires after its power is turned on the numeric values representing tire locations displayed on the screen all become "E1".

1. There is interference from other electronic device in the vehicle.

Solution : Remove other electronic device in the vehicle to determine if TPMS is interfered by those removed devices.

2. The inner circuits of the display panel failed.

Solution : Ask your distributor to have your receiver replaced, reconfigure its ID using the Tire Switching Mode (Mode IV), and send the defected receiver back to manufacturer for repair.

5. The buzzer has no sound output.

1. The inner circuits of the receiver failed.

Solution : Ask your distributor to have your receiver replaced, reconfigure the IDs of the tires using the Tire Switching Mode(Mode IV),and then send the defected receiver back to manufacturer for repair

6. The pressure (or temperature)values show the wrong tire locations

1. The IDs of the four tires are not configures correctly

Solution : Ask your installation supplier to reconfigure the IDs of the tires by using the Tire Switching Mode (Mode IV or Mode V).

2. After rotating the tires, it cannot reconfigure the IDs from sensors.

Solution : Ask your installation supplier to reconfigure the IDs of the tires by using the Tire Switching Mode (Mode IV or Mode V).

Thank you for your purchase and enjoy your TPMS!

Manufacturer:

Orange Electronic Co., LTD

[www.orange-electronic.com](http://www.orange-electronic.com)

5F, No.29, Keya Rd, Central Taiwan Science Park, Taichung 42881, Taiwan

Phone: +886-4-2560-2766

Email: [service@orange-electronic.com](mailto:service@orange-electronic.com)